

S8741-1

NL

F

GB

D

Bedankt voor de aanschaf van dit product.

Nous tenons à vous remercier pour l'acquisition de ce produit.

Thank you for acquiring this product.

Vielen Dank für den Kauf dieses Produkt.

Bij eventuele schade of problemen, vragen wij u onze website **www.solid.eu/sav** te raadplegen en de procedure te volgen die op onze website uitgelegd wordt. Als u niet in de mogelijkheid bent om via het web de aanvraag te doen, vragen wij u te begeven naar de winkel waar u uw constructie heeft gekocht, samen met de beschadigde stukken (of met een foto) en met de **Stuklijst**, terug te vinden in het montageplan, zodat een eerste controle door de winkel uitgevoerd kan worden. Vergeet ook niet de barcode (beginnend met ASKAO) mee te nemen of ze te vermelden op de **Stuklijst** op de voorziene plaats. U kan deze terug vinden op het etiket op de verpakking van de constructie ofwel op de leveringsbon. (zie uitleg hieronder)
Al deze zaken zijn onontbeerlijk en dus noodzakelijk voor de behandeling van uw klacht.

En cas de problèmes ou de dégâts, nous vous invitons à vous rendre sur le lien internet suivant **www.solid.eu/sav** et à suivre la procédure indiquée sur la page web. S'il ne vous est pas possible de vous rendre sur internet, il vous est demandé de prendre contact avec le magasin où vous avez acheté votre produit, muni des pièces défectueuses (ou d'une photo) et la **Liste des pièces** figurant dans le plan de montage, afin qu'un premier contrôle puisse être effectué par le magasin. Veuillez transmettre le code barres (commençant par ASKAO), ou le mentionner dans la **Liste des pièces** à l'endroit indiqué. Vous le trouverez sur l'étiquette de l'emballage de votre produit ou sur le bon de livraison (voir explication ci-dessous). Ces données sont indispensables au traitement de votre réclamation.

In case of problems or damages please visit our website **www.solid.eu/sav** and follow the instructions. If not possible to access our webpage by internet please contact the shop where the product was bought, provided with the flawed parts (or with a picture) and the **Bill of material** enclosed in the assembly plan, so that the shop can carry out a first control. Also communicate the following bar code (beginning with ASKAO) or mention it in the **Bill of material** in the field provided. You can locate the bar code on the label fixed on the packaging or on the delivery order. (explained below) information is needed in order to handle your claim.

Bitte wenden Sie sich bei eventuellen Beschädigungen oder Problemen an unsere website **www.solid.eu/sav** und folgen sie unseren Website. Wenn Sie nicht in der möglichkeit die Anforderung über das internet zu machen, bitte wenden Sie sich an den Händler, bei dem Sie Ihr Produkt gekauft haben, und nehmen Sie die beschädigten Teile (oder ein Foto davon) sowie der **Materialliste**, das Sie im Montageplan finden, mit, sodass ihr Händler das Problem untersuchen kann. Bitte denken Sie auch an unten stehenden Barcode (beginnend mit ASKAO). Nehmen Sie diesen ebenfalls mit oder geben Sie ihn an der dafür vorgesehenen Stelle auf dem **Materialliste** an. Sie können diese zurück finden auf das Etiket von der Verpackung der Konstruktion oder auf der Lieferschein (siehe Erklärung unten) Oben genannte Informationen und Dokumente sind für die Bearbeitung Ihrer Beschwerde notwendig.



- (NL) Verpakking
- (F) Emballage
- (GB) Packaging
- (D) Verpackung



- (NL) Sticker
- (F) Autocollant
- (GB) Sticker
- (D) Aufkleber



ASKAOxxxxxxxxxx

SOLID creating outdoor comfort

Kopie pakbon **M614-00673**

SOLID B.V.A.
INDUSTRIEL 5
8811 ESHORRES
www.solid.eu

RIJN EN
ST. OIK. VEREINIGING
3.10.1912 (E.I.)
142114 1386 (R.V.S.)

Leveringsdatum: 14/01/2013	Leveringsadres: enklant	Aankomst: 14/01/2013
Order nr: 13010000000000000000	Order nr: 13010000000000000000	Order nr: 13010000000000000000
Bestelgegevens: 13010000000000000000	Bestelgegevens: 13010000000000000000	Bestelgegevens: 13010000000000000000

Klant: **VEREINIGING**

Voorwaarde: **VEREINIGING**

Leveringsmethode: **VEREINIGING**

Orderaanvraag: **VEREINIGING**

Sluitingsperiode: **VEREINIGING**

Aankomstdatum	Ref. klant	Omschrijving	Lengte	Kleur	Kwaliteit
S8741-1					

Serial ID: **ASKAOxxxxxxxxxx**

Aantal coli: **1**

Aantal pallets: **1**

Totaal gewicht: **9,00 KG**

Handtekening: _____

Indien gewenst verzorgen wij de montage van uw product aan heel interessante prijzen.
Contacteer ons op montage@solid.eu of 05646 16 75

Contacteer ons:
www.solid.eu
op onze website vindt u alle informatie over uw product, montageplan, montageplannen en veelgestelde vragen
www.solid.eu/sav
mits u een probleem met het product (probleem, verkeerde, defecte... onderdelen), gelieve het online formulier in te vullen
montage@solid.eu
verst u een montageplan in te schakelen voor het plaatsen van uw product, gelieve ons per mail te contacteren

Solid B.V.A. aanvaardt geen aansprakelijkheid voor schade van welke aard ook die voortvloeit uit het gebruik van de producten van Solid B.V.A. De aansprakelijkheid voor schade van welke aard ook die voortvloeit uit het gebruik van de producten van Solid B.V.A. aanvaardt geen aansprakelijkheid voor schade van welke aard ook die voortvloeit uit het gebruik van de producten van Solid B.V.A.

Totaal volume: **1**

DE CLAUSULE VAN EIGENDOMSVOORBEHOUD IS VAN TOEPASSING BIJ DEZE LEVERING IN GOEDE STAAT ONTVANGEN.

Inclusie van: **VEREINIGING**

Productie van: **VEREINIGING**

Verpakking van: **VEREINIGING**

Verpakking van: **VEREINIGING**

- (NL) Leveringsbon
- (F) Bon de livraison
- (GB) Delivery note
- (D) Lieferbeleg

- Dienst na verkoop (NL)
- Service Après Vente (F)
- After Sales Service (GB)
- Kundendienst (D)

Stuklijst / Liste des pièces / Bill of material / Materialliste

S8741-1

Ref.	Index	#
A	VEREINIGING	2
B	VEREINIGING	19
C	VEREINIGING	7
D	VEREINIGING	4
E	VEREINIGING	24
F	VEREINIGING	2
G	VEREINIGING	13
H	VEREINIGING	2
I	VEREINIGING	48
J	VEREINIGING	2
K	VEREINIGING	3
L	VEREINIGING	7
M	VEREINIGING	4
N	VEREINIGING	2
O	VEREINIGING	1
P	S8741-1	1

Gereedschap (exc1) / Outils (exc1) / Tools (exc1) / Werkzeuge (exc1)

S8740-1

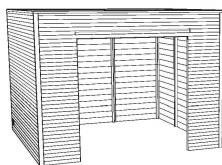

ASKAO



Ref. Index #

Ref.	Index	#
A1	WP019x123-CDEV-TPP-1-0448x2870	1
A2	WP019x123-CDER-TPP-1-1120x2870	1
A3	WP019x123-CGAU-TPP-1-1120x2870	1
A4	WP019x123-CDRO-TPP-1-1120x2870	1
B1	WP019x123-CPPN-000-1-1131x2870	1
B2	WP019x123-CPPN-000-1-1131x2870	2
C	WP019x123-CPPU-000-1-2160x0545	2
D1	WW040x040-4FA-000-1-2066	2
D2	WW040x040-4FA-000-1-2056	2
D3	WW028x040-4FA-000-1-2132	2
J	WW016x095-PLA-000-1-2867	34
K	WW040x145-4FA-IF0-1-2950	2
L	WW019x059-4FA-000-1-2240	4
O	S5015 EPDM (3200x3200)	1

Afmetingen, uiterlijk, vorm, gewicht kunnen afwijken.
 Les dimensions, l'apparence, la forme, le poids peuvent différer.
 Dimensions, appearance, shape, weight may differ.
 Maße, Aussehen, Form, Gewicht können abweichen.

www.solid.eu/sav

Gereedschap (excl.) / Outils (excl.) / Tools (excl.) / Werkzeuge (exkl.)



Hamer
Marteau
Hammer
Hammer



Schroefboormachine
Perceuse / Visseuse
Screw drill
Schraubenbohrer



Ladder
Echelle
Ladder
Leiter



Winkelhaak
Crochet carré
Square hook
Quadratischer Haken



Cirkelzaag
Scie circulaire
Circular saw
Kreissäge



Klokboor Ø 60mm
Scie cloche Ø 60mm
Hole saw Ø 60mm
Bohren Ø 60mm



Handzaag
Scie à main
Saw
Säge



Meter
Mètre
Meter
Rollenmesser



Breekmes
Couteau
Cutter
Messer



Waterpas
Niveau à bulle
Plumb rule
Wasserwaage















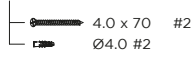



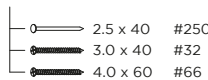

Decoupeerzaag
Scie sauteuse
Jigsaw
Stichsäge



Silicone + pomp
Silicone + pompe
Silicone + pump
Silikon + Pumpe

S8740-1

	Ref.	Index	#
	O1	S5010 Contactspray	4
	P	#####	1
	P	#####	1
	P	S618 	1
	P	S80201	1
	P	S6203-L	3
	P	S6203-R	3
	P		1
	R	S8740-Zmt 	1
	V1	S5018 Drainage pipe connection	1
	V2	S5232 Drainage pipe	1
	V3	S5238 Drainage pipe corner 45°	2
	V4	S5236 Fixo PVC	2
	Z	S6746 Ventilation-kit	1
	X1	S6707 25x25x3 CENTER (2996)	2
	X2	S6707 25x25x3 CENTER (2916)	2

Afmetingen, uiterlijk, vorm, gewicht kunnen afwijken.
Les dimensions, l'apparence, la forme, le poids peuvent différer.
Dimensions, appearance, shape, weight may differ.
Maße, Aussehen, Form, Gewicht können abweichen.

www.solid.eu/sav

Gereedschap (excl.) / Outils (excl.) / Tools (excl.) / Werkzeuge (exkl.)



Hamer
Marteau
Hammer
Hammer



Schroefboormachine
Perceuse / Visseuse
Screw drill
Schraubenbohrer



Ladder
Echelle
Ladder
Leiter



Winkelhaak
Crochet carré
Square hook
Quadratischer Haken



Cirkelzaag
Scie circulaire
Circular saw
Kreissäge



Klokboor Ø 60mm
Scie cloche Ø 60mm
Hole saw Ø 60mm
Bohren Ø 60mm



Handzaag
Scie à main
Saw
Säge



Meter
Mètre
Meter
Rollenmesser



Breekmes
Couteau
Cutter
Messer



Waterpas
Niveau à bulle
Plumb rule
Wasserwaage



Decoupeerzaag
Scie sauteuse
Jigsaw
Stichsäge



Silicone + pomp
Silicone + pompe
Silicone + pump
Silikon + Pumpe

S8054-1

Ref.

Index

#

ok/nok



ASKAO

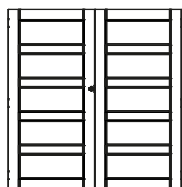
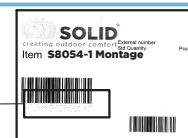

↓	↓	↓
P	S8054-1	1

Stuklijst / Liste des pièces / Bill of material / Materialliste



S8730-1

Ref.	Index	#	# nok
P	S8054-K-1	1	
	S8084-ALU	1	
	S618	1	
	4.0 x 70 #2 Ø4.0 #2	1	
	S80201	1	
	S6203-L	3	
	S6203-R	3	
	S673 (x2)	1	



Tip / Conseil / Advice / Beratung

Het kan gebeuren dat er vlekjes op het glas zichtbaar zijn. Dit is het gevolg van de impregnatie. Deze kunnen verwijderd worden met warm water en een niet-schurende spons. Een wonderspons kan ook gebruikt worden ofwel met ijzerwol '000'.



Il peut arriver que des taches soient visibles sur le verre. C'est le résultat de l'imprégnation. Ceux-ci peuvent être enlevés avec de l'eau tiède et une éponge non abrasive. Une éponge miracle peut également être utilisée, ou avec de la laine de fer '000'.



It may happen that spots are visible on the glass. This is the result of the impregnation. These spots can be removed with warm water and a non-abrasive sponge. A miracle sponge can also be used, or iron wool '000'.



Es kann vorkommen, dass Flecken auf dem Glas sichtbar sind. Dies ist das Ergebnis der Imprägnierung. Diese können mit warmem Wasser und einem nicht scheuernden Schwamm entfernt werden. Ein Wunderschwamm kann auch mit Eisenwolle '000' verwendet werden.

Gereedschap (excl.) / Outils (excl.) / Tools (excl.) / Werkzeuge (exkl.)



Hamer
Marteau
Hammer
Hammer



Schroefboormachine
Perceuse / Visseuse
Screw drill
Schraubenbohrer



Ladder
Echelle
Ladder
Leiter



Winkelhaak
Crochet carré
Square hook
Quadratischer Haken



Cirkelzaag
Scie circulaire
Circular saw
Kreissäge



Klokboor Ø 60mm
Scie cloche Ø 60mm
Hole saw Ø 60mm
Bohren Ø 60mm



Handzaag
Scie à main
Saw
Säge



Meter
Mètre
Meter
Rollenmesser

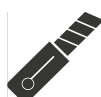

Breekmas
Couteau
Cutter
Messer



Waterpas
Niveau à bulle
Plumb rule
Wasserwaage



Decoupeerzaag
Scie sauteuse
Jigsaw
Stichsäge



Silicone + pomp
Silicone + pompe
Silicone + pump
Silikon + Pumpe

NL

Bij de montageschappen waar onderstaand pictogram staat is het aangewezen om silicone aan te brengen.

F

Il est recommandé d'appliquer du silicone pendant les étapes de montage où l'icône ci-dessous est affichée.

GB

It is recommended to apply silicone during the assembly steps where the icon below is shown.

D

Es wird empfohlen, während der Montageschritte Silikon aufzutragen, wenn das Symbol unten angezeigt wird.

!! Silicone aanbrengen (excl.)
!! Appliquer du silicone (excl.)
!! Apply silicone (excl.)
!! Silikon auftragen (excl.)

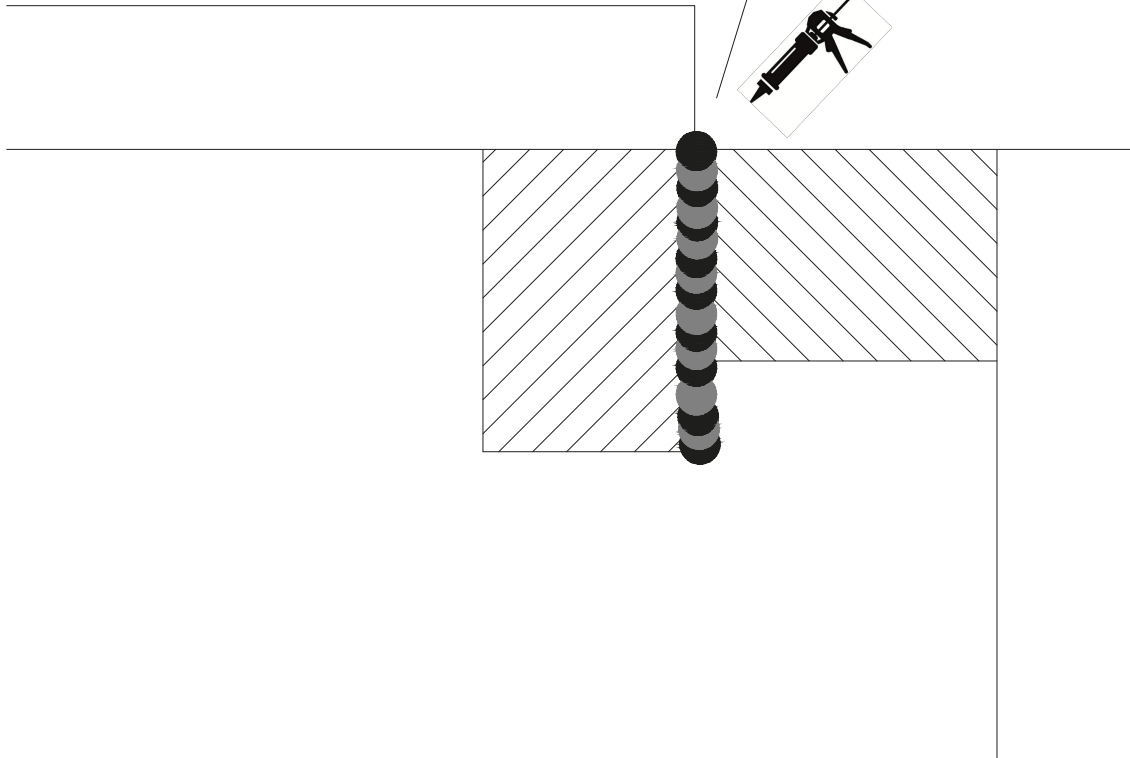

S8740-1

B1 = 1
B2 = 1
 4.0 x 60 # 4

1

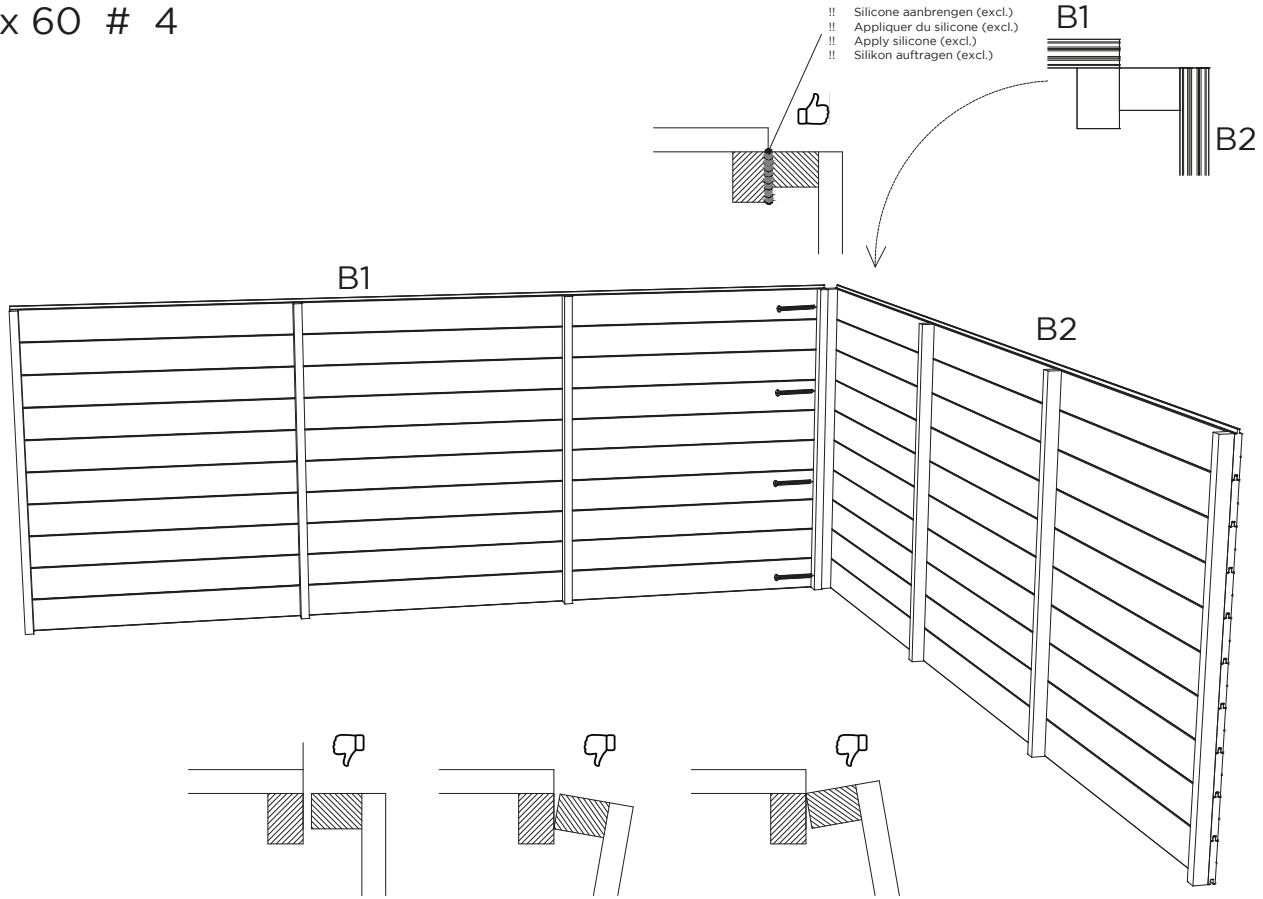

B2 = 1
 4.0 x 60 # 4

2

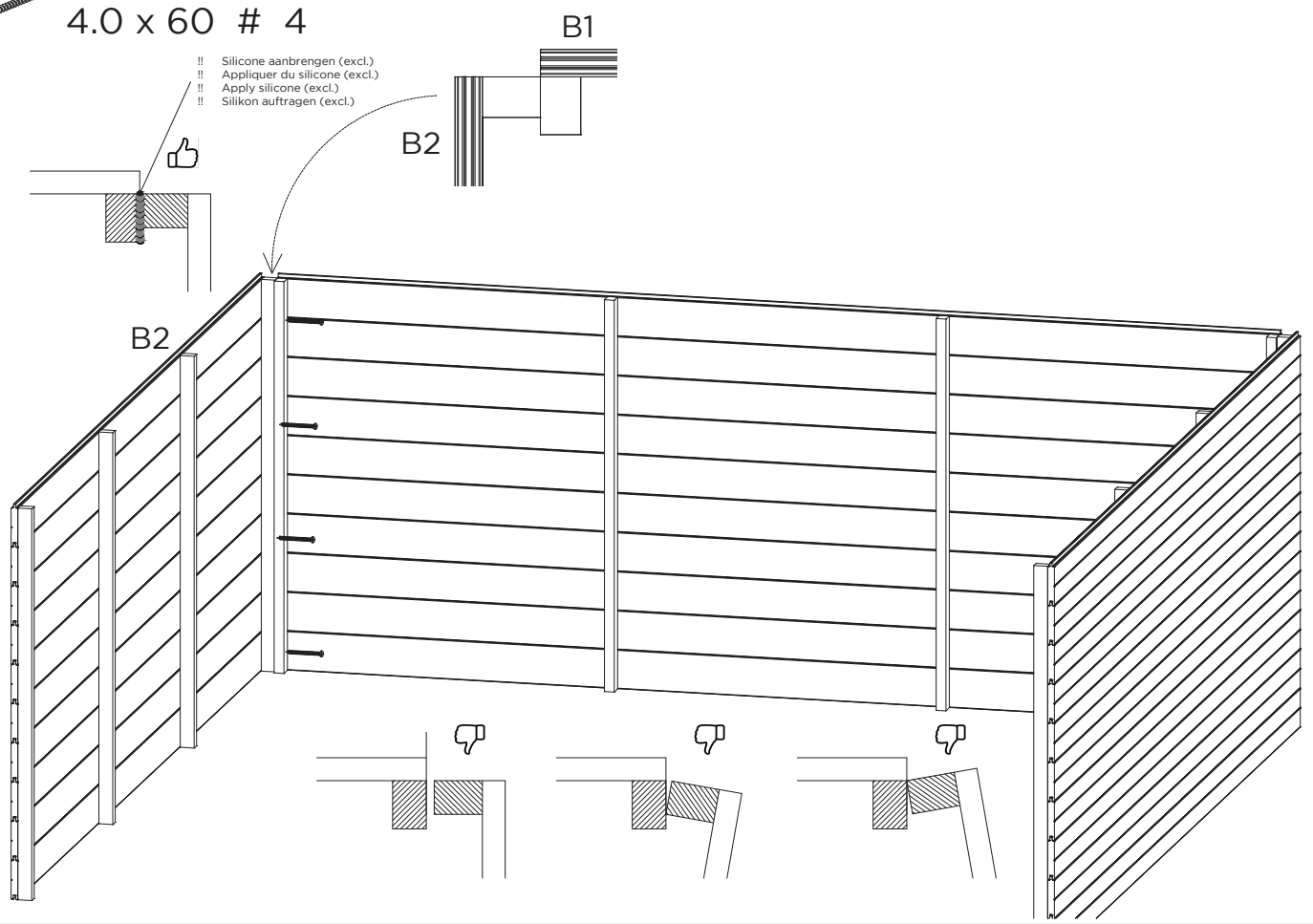

S8740-1

C = 2
4.0 x 60 # 8

3

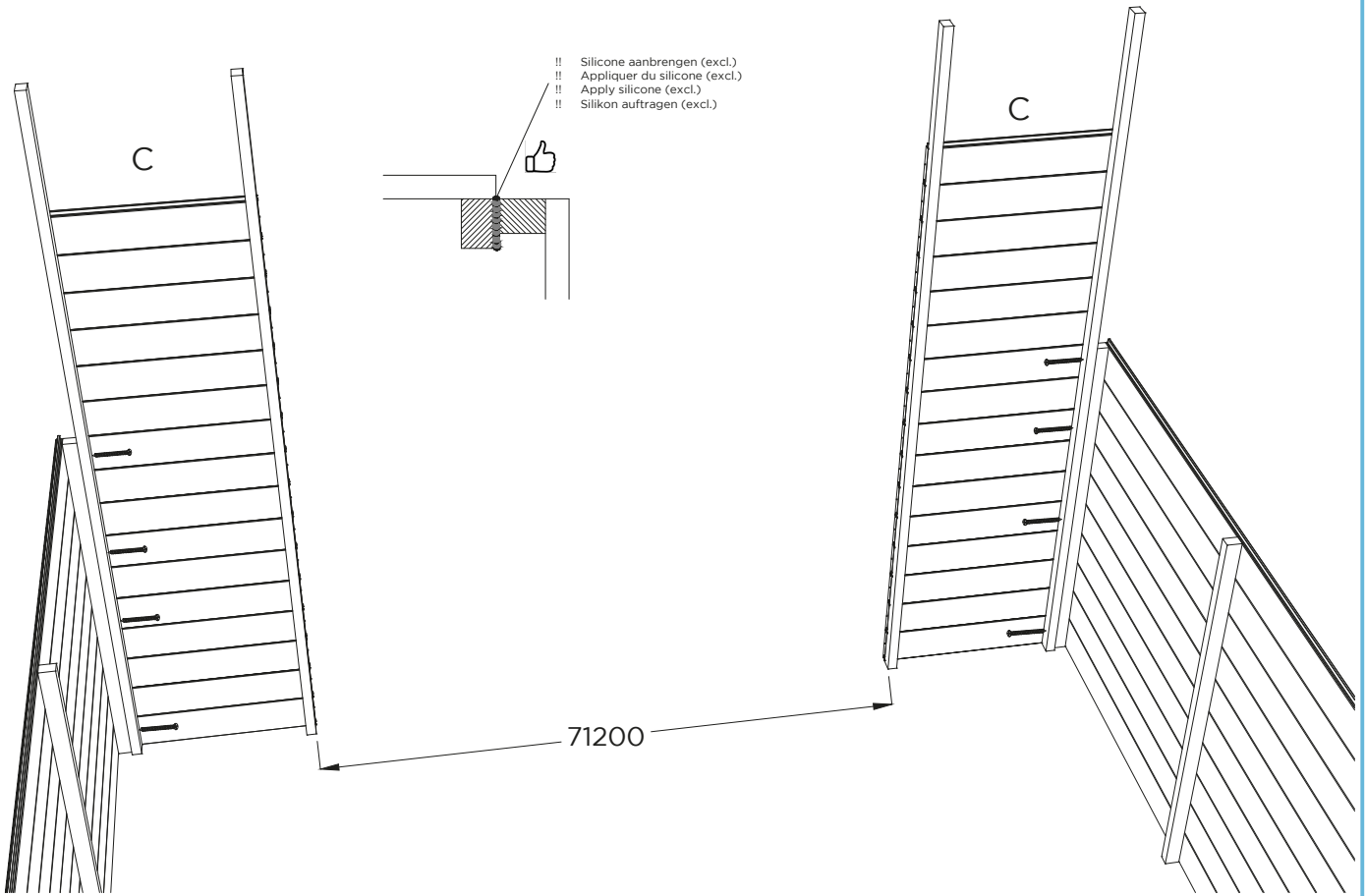

A2 = 1
A3 = 1
A4 = 1
4.0 x 60 # 16

4

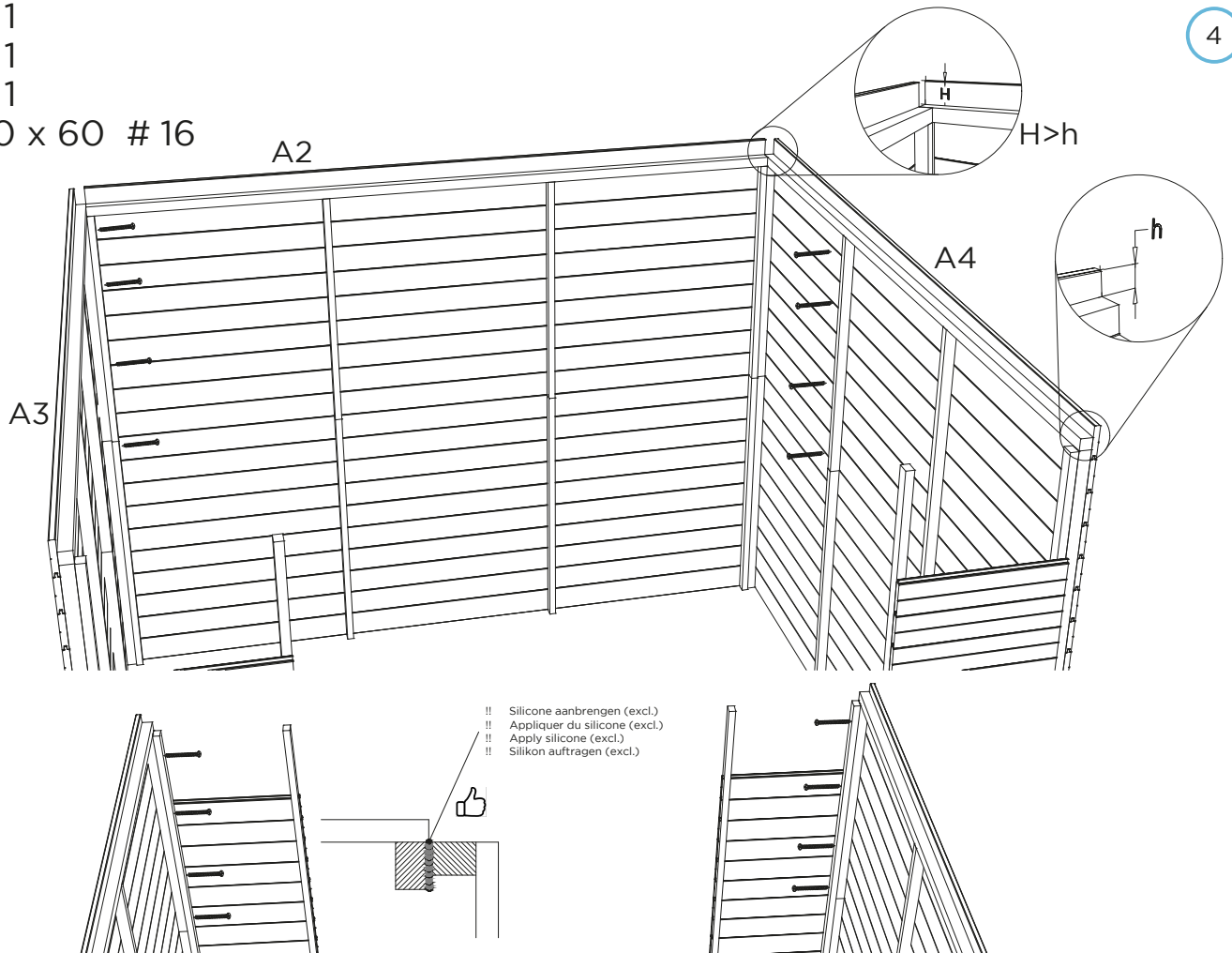

S8740-1

A1 = 1
4.0 x 60 # 10

5

- !! Silicone aanbrengen (excl.)
- !! Appliquer du silicone (excl.)
- !! Apply silicone (excl.)
- !! Silikon auftragen (excl.)

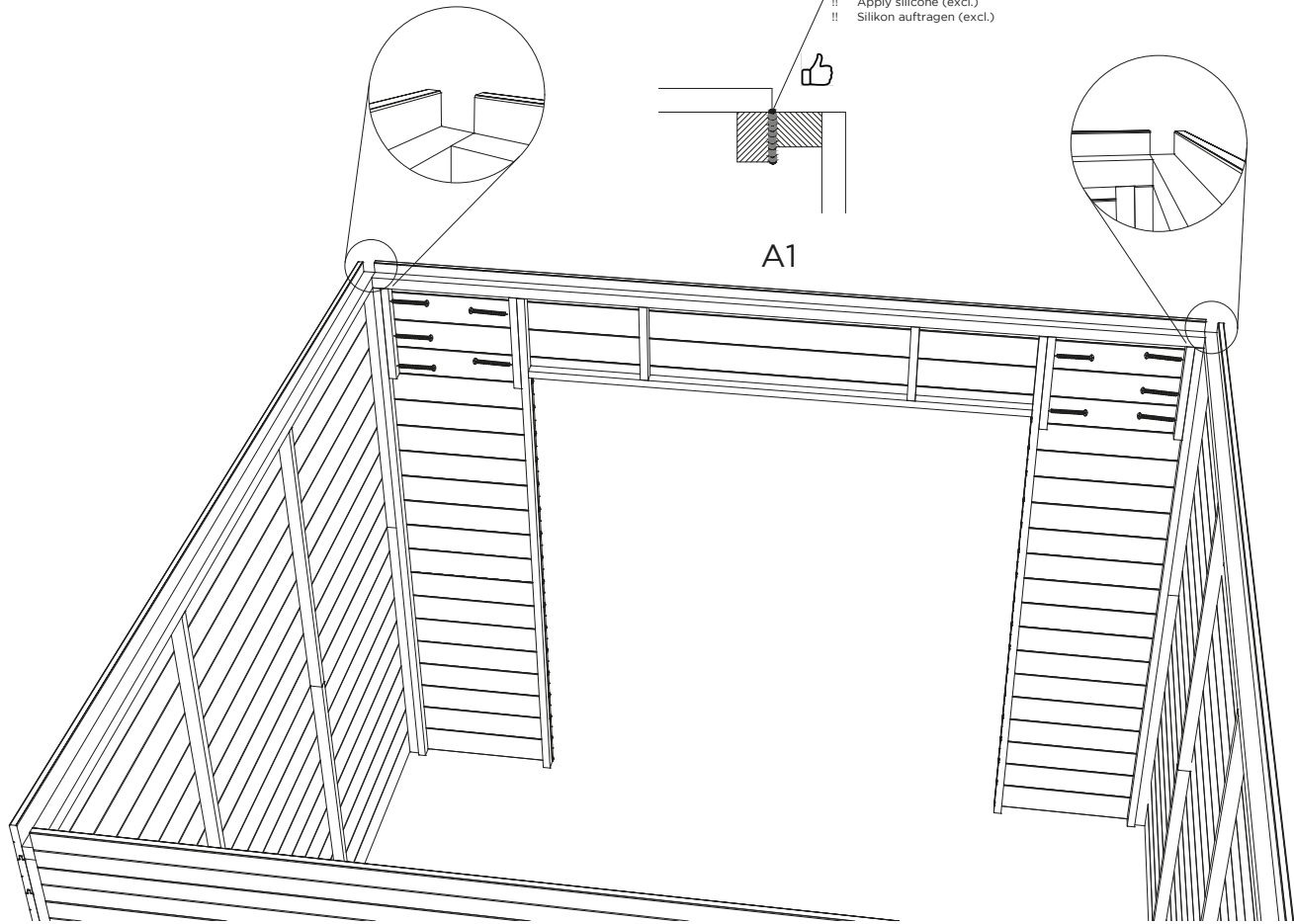



K = 2
4.0 x 60 # 4

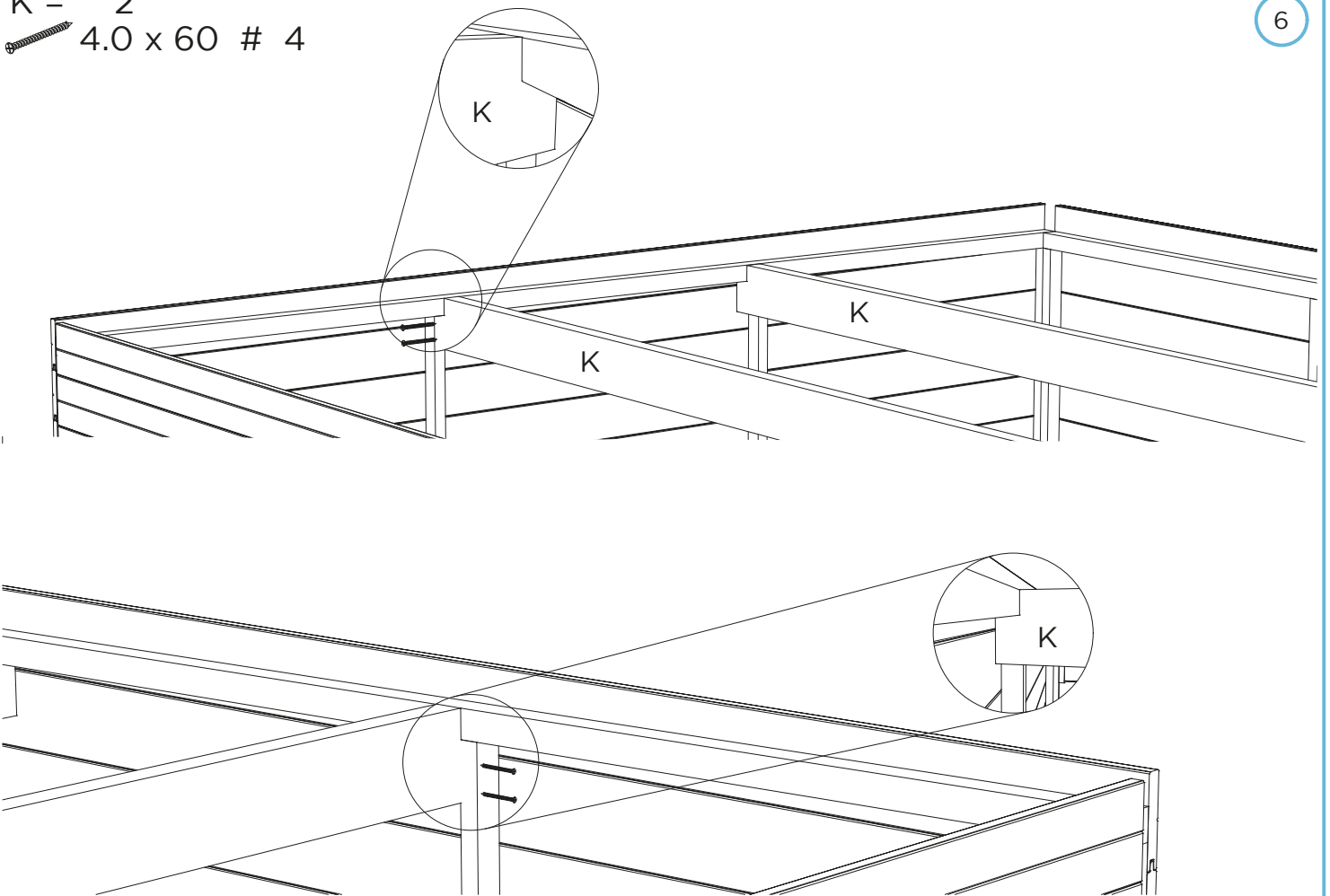

6

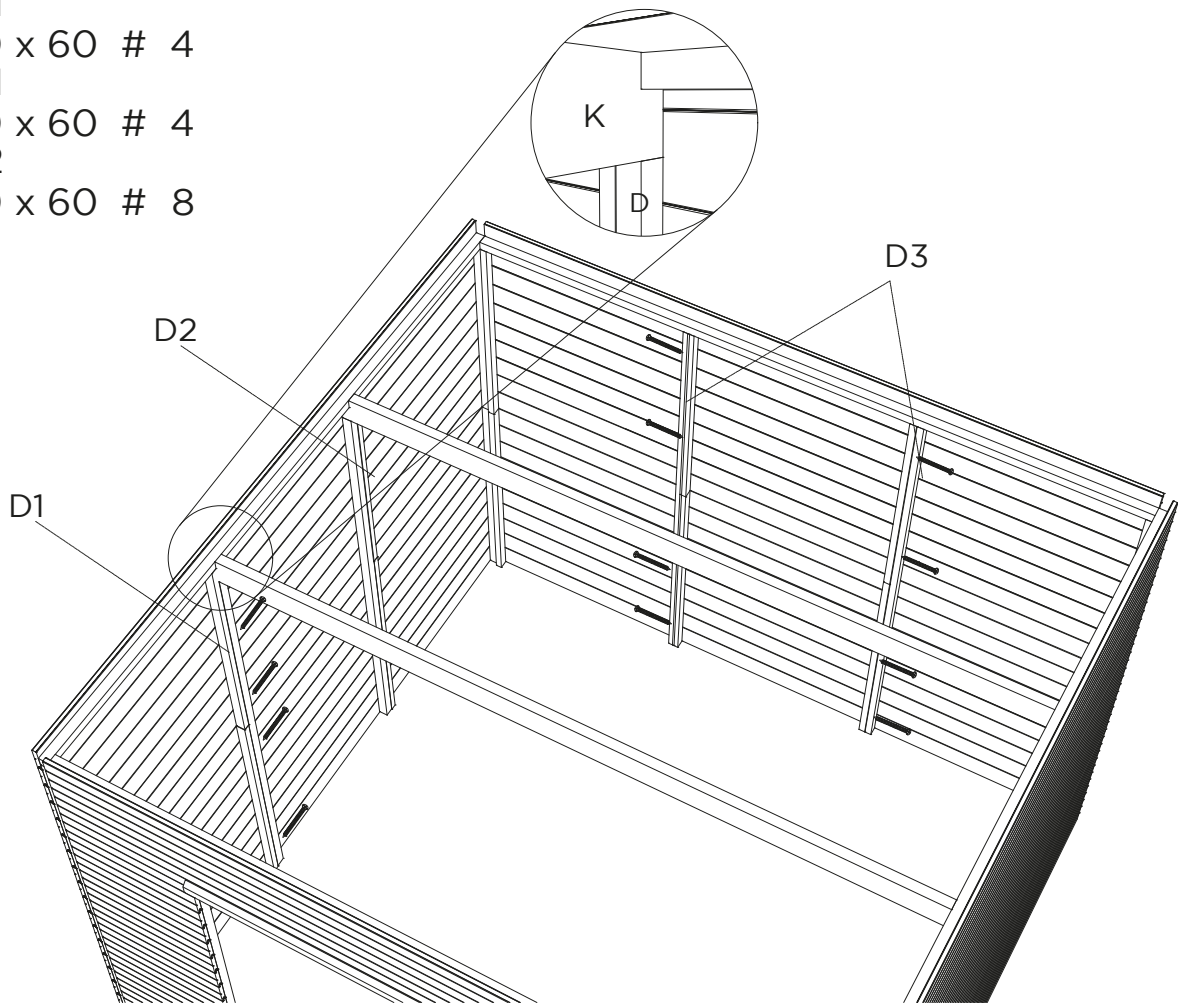

S8740-1

- D1 = 1
 4.0 x 60 # 4
- D2 = 1
 4.0 x 60 # 4
- D3 = 2
 4.0 x 60 # 8



- D1 = 1
 4.0 x 60 # 4
- D2 = 1
 4.0 x 60 # 4

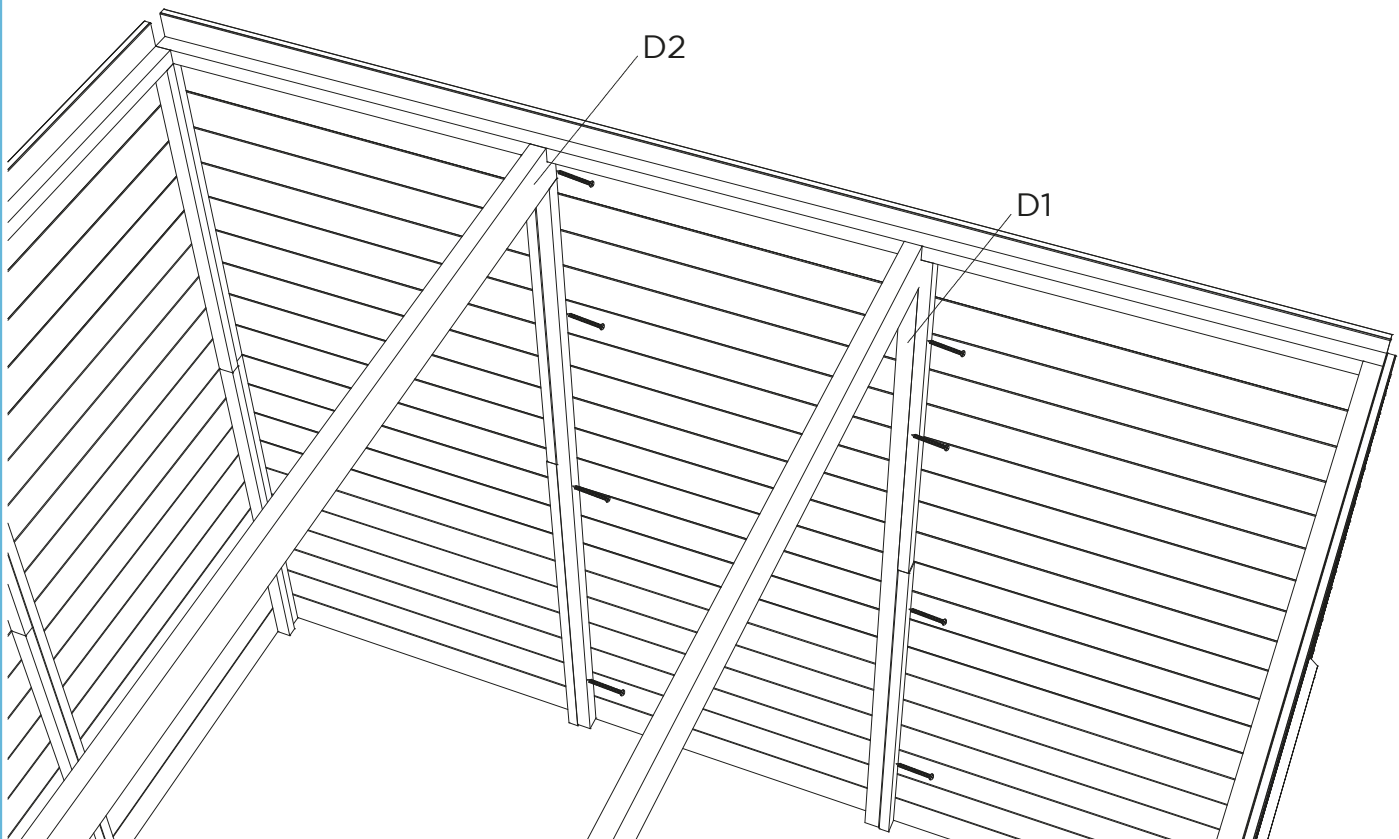

S8740-1

J = 34
2.5 x 40 # 180



min. 2 mm !!

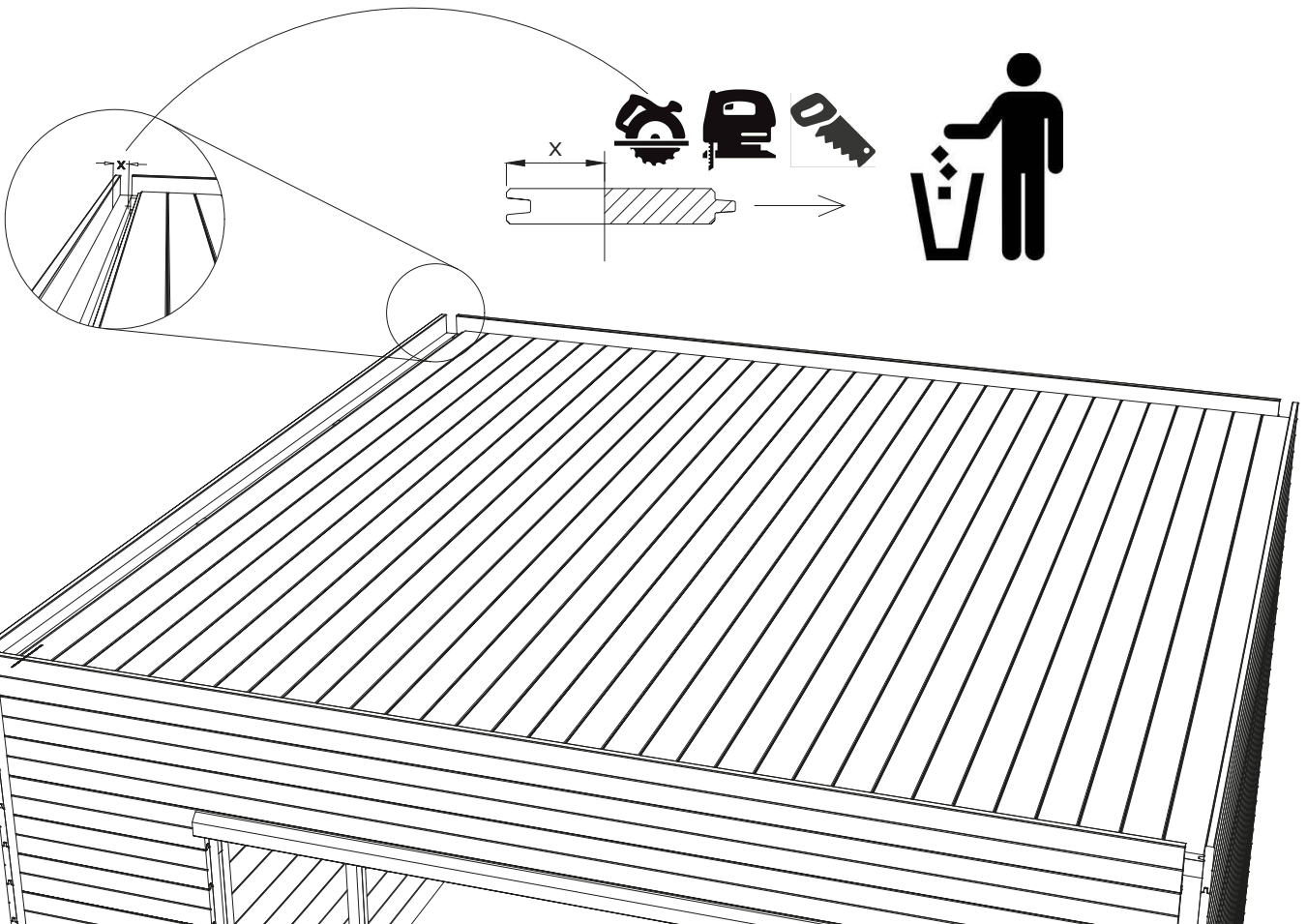
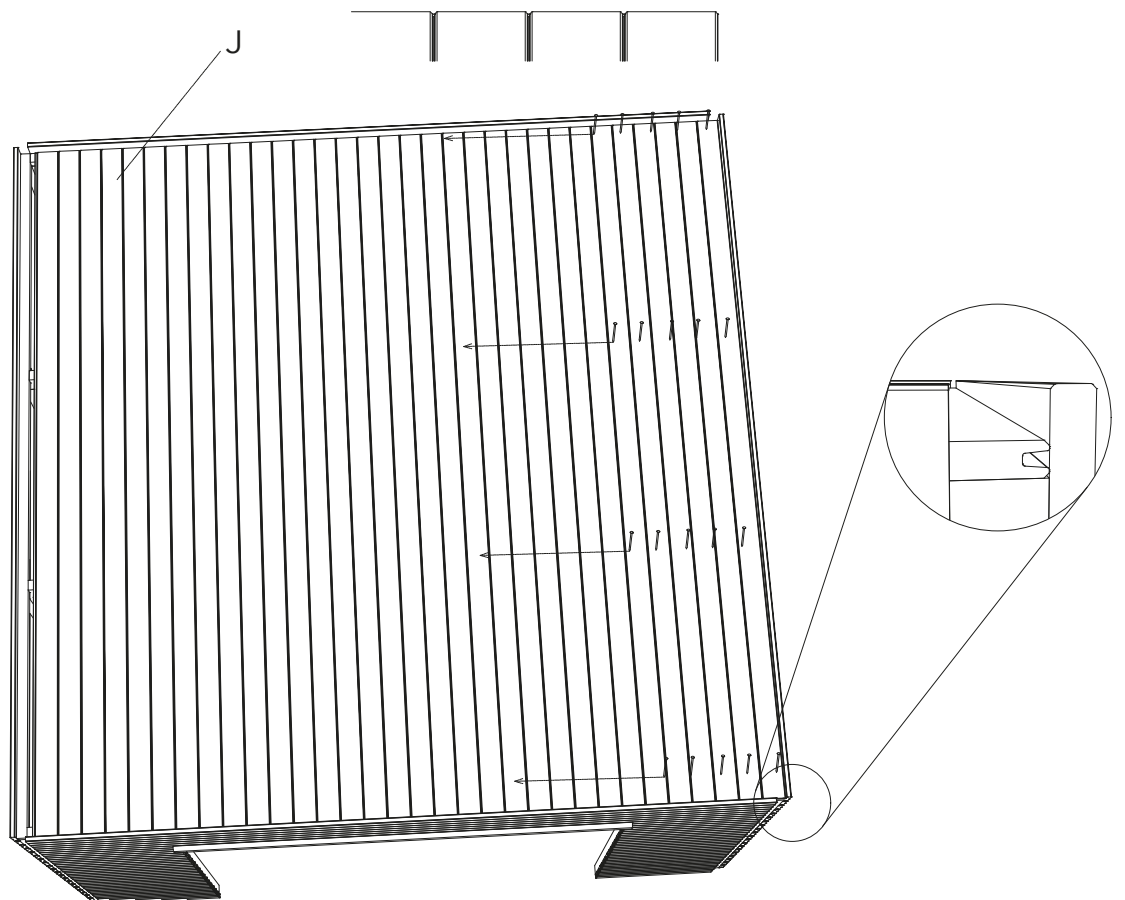

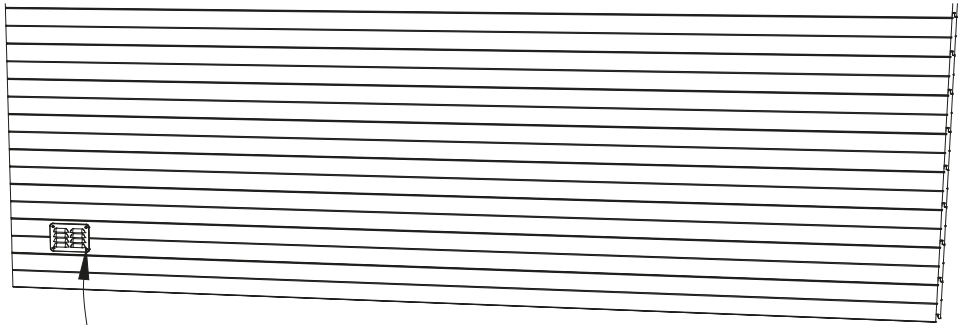
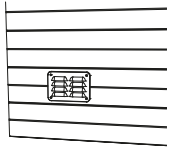

S6746 Ventilation-kit

S8741-1 BARI

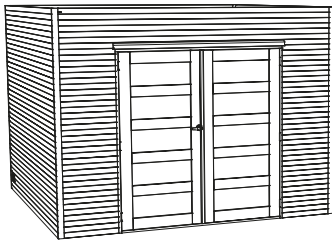

S8740-1
L = 4
3.0 x 40 # 16

Ga verder met de handleiding van **S8740-1**.

Continuer avec le manuel de **S8740-1**.

Continue with the manual from **S8740-1**.

Fahren Sie mit dem Handbuch von fort **S8740-1**.

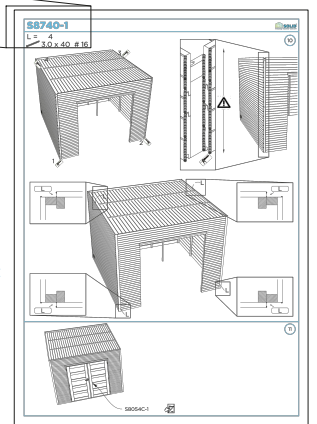

S8742-1 TARENTO

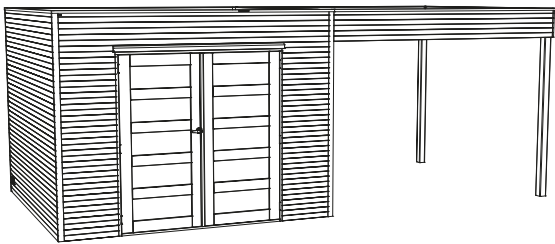

S8751-1
L = 4

Ga verder met de handleiding van **S8751-1**.

Continuer avec le manuel de **S8751-1**.

Continue with the manual from **S8751-1**.

Fahren Sie mit dem Handbuch von fort **S8751-1**.

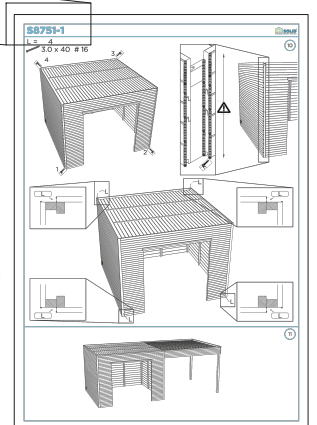

S8743-1 MATERA

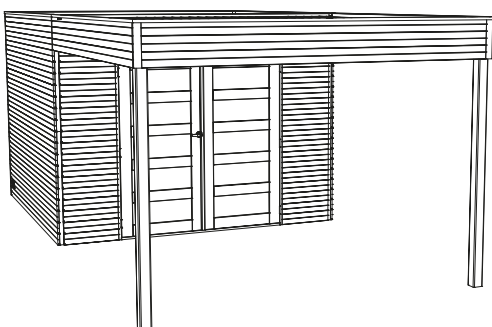

S8730-1 / S8740-1
L = 4

Ga verder met de handleiding van **S8752-1**.

Continuer avec le manuel de **S8752-1**.

Continue with the manual from **S8752-1**.

Fahren Sie mit dem Handbuch von fort **S8752-1**.

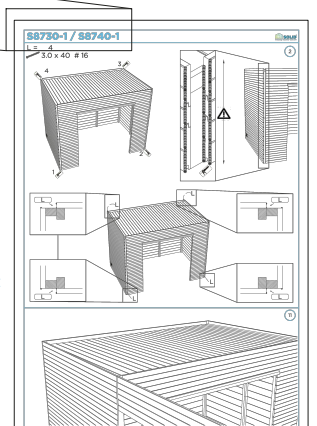

S8740-1

L = 4
3.0 x 40 # 16

10

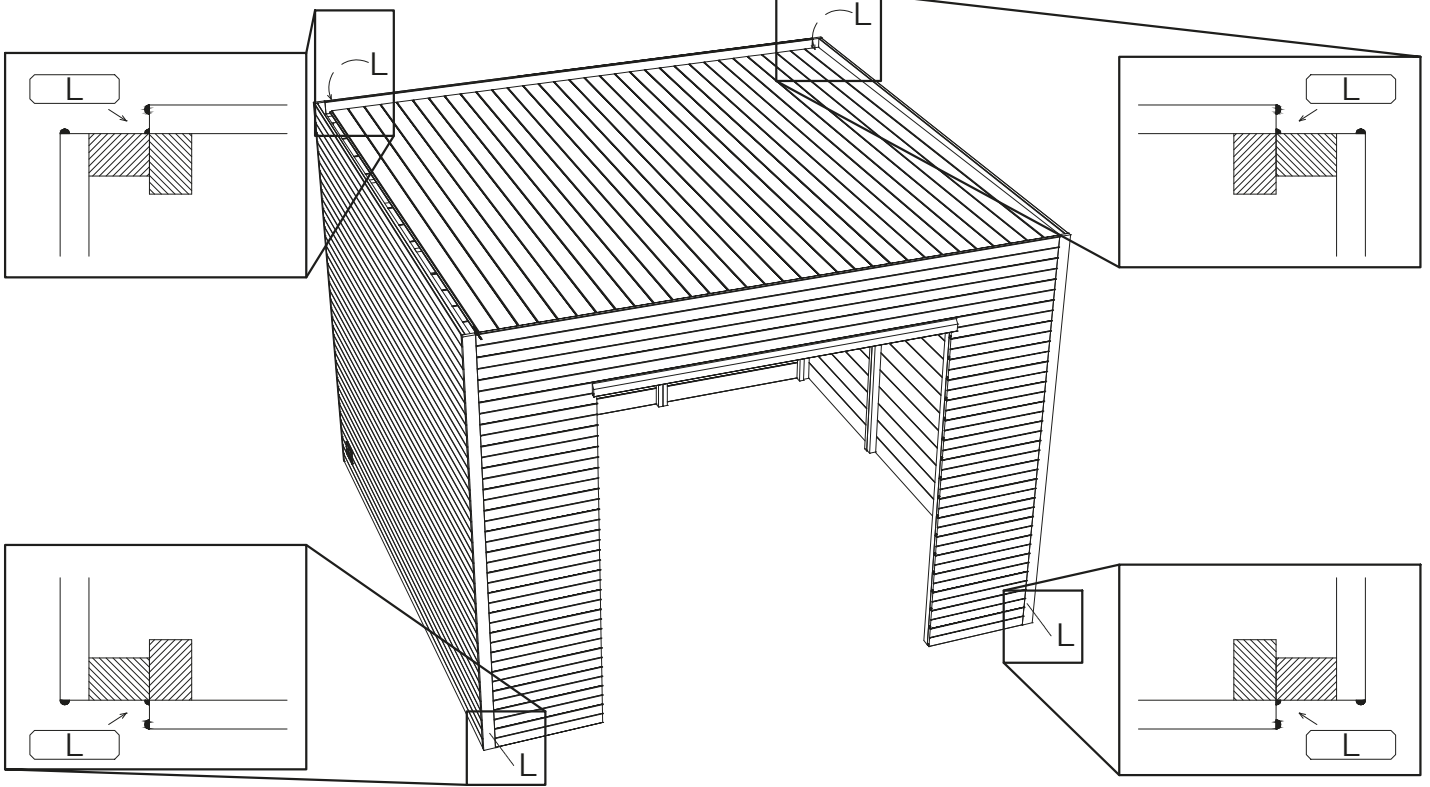
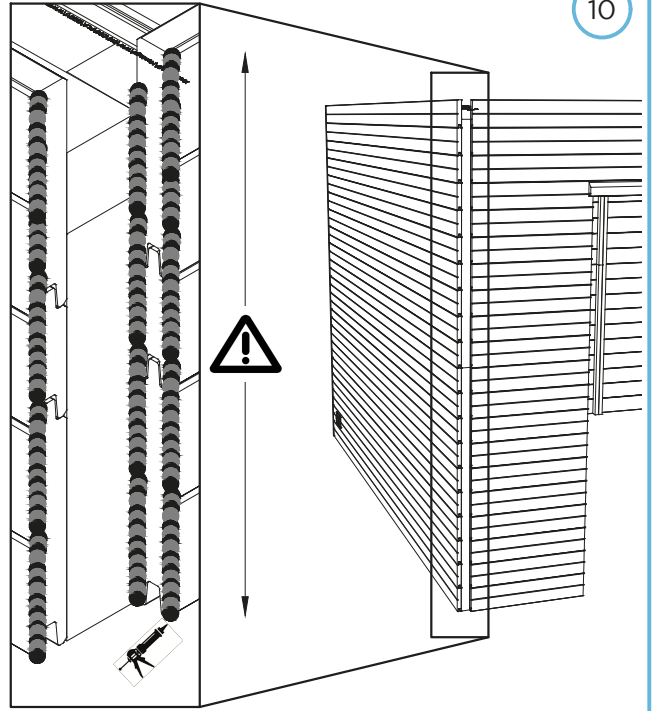
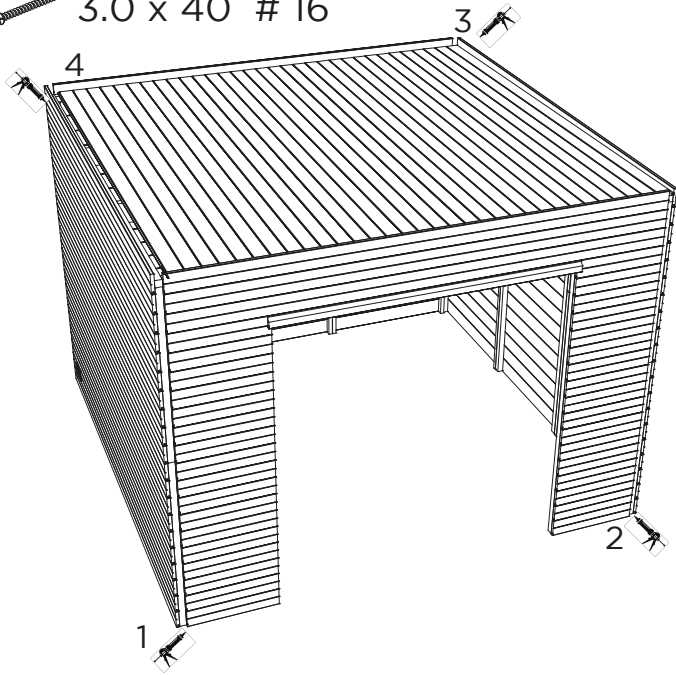

11

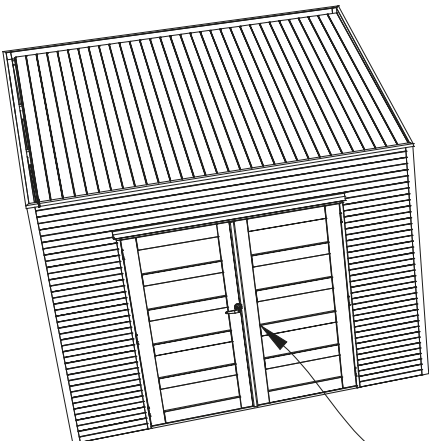

S8054C-1



S8054-1

4.0 x 50 # 2

1

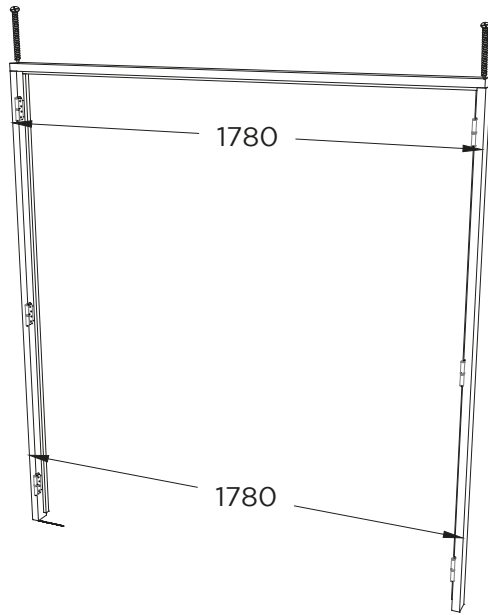

2

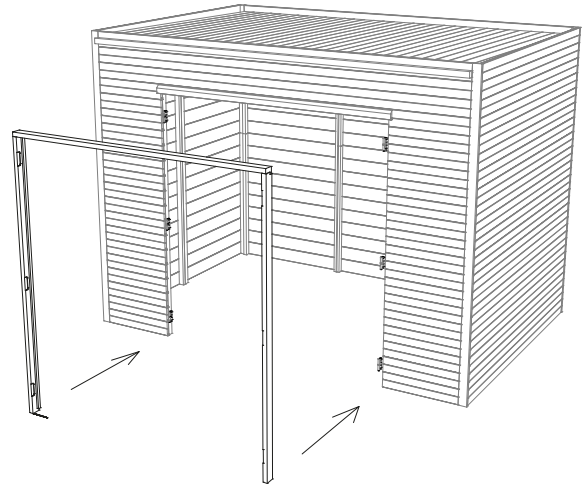

4.0 x 50 # 11

3

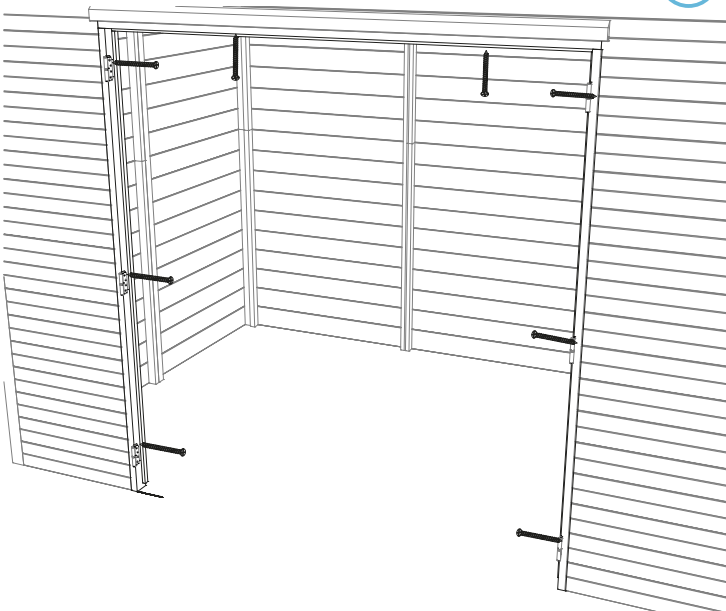

4

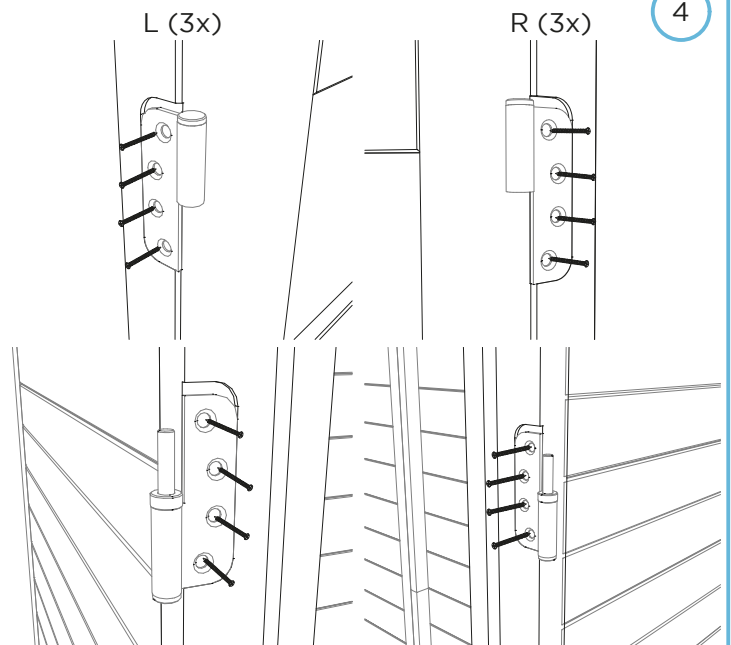

5

4.0 x 30 # 4

6

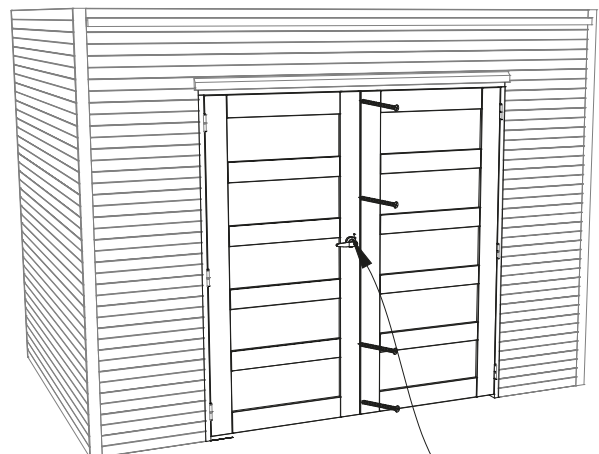
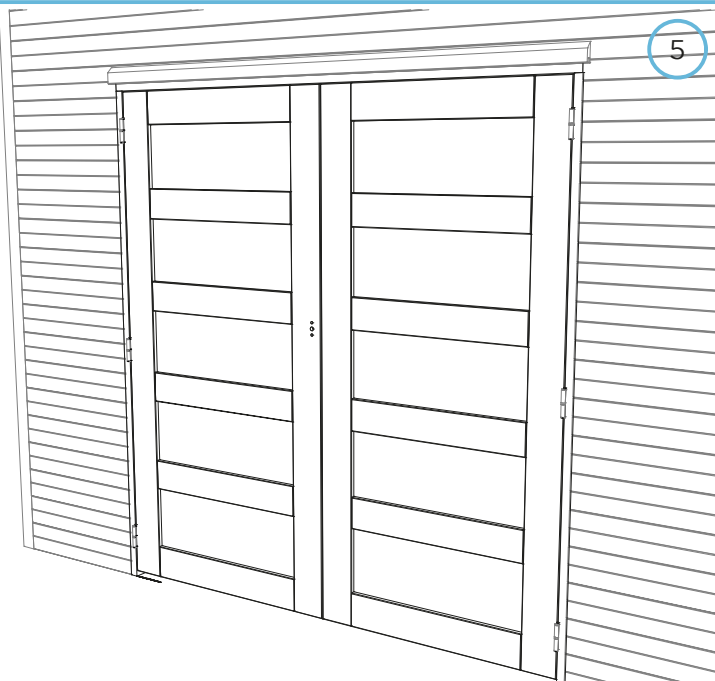

S80201 

EPDM (CONTACTSPRAY)

1

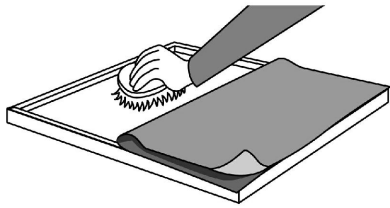

2

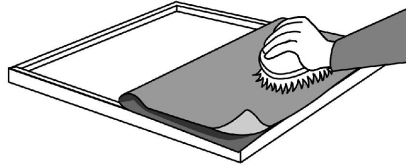

3

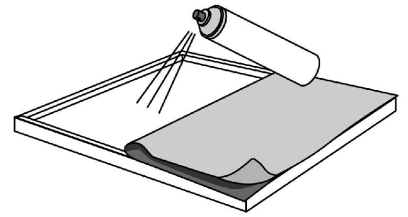

4

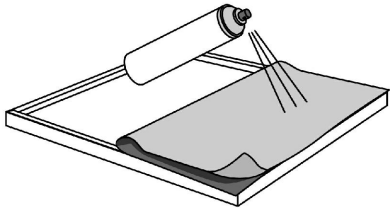

5

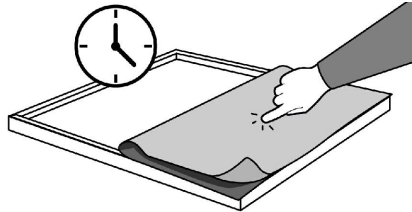

6

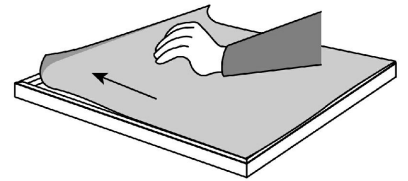

7

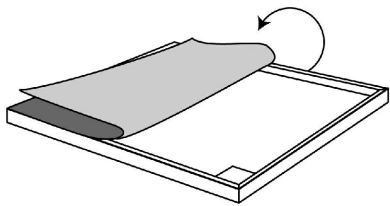

8

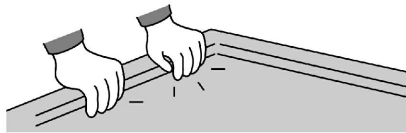

9



10



11

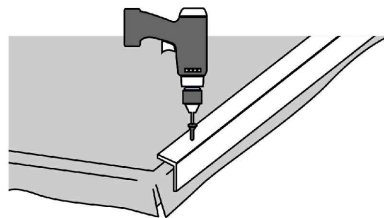

12

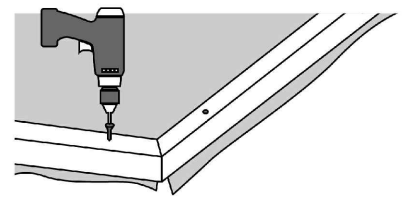

13

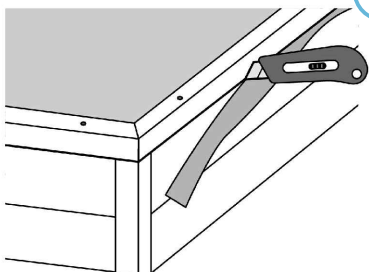

14

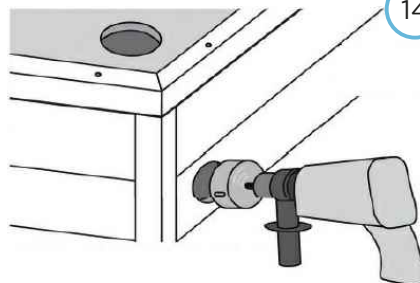

15

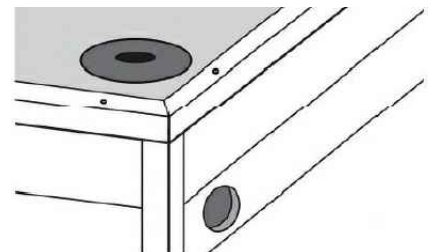

16

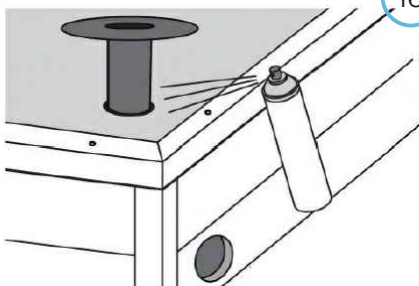

17

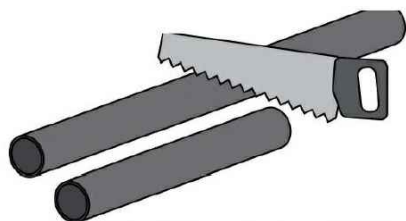

18

